

strutture modulari in alluminio
per l'allestimento fieristico

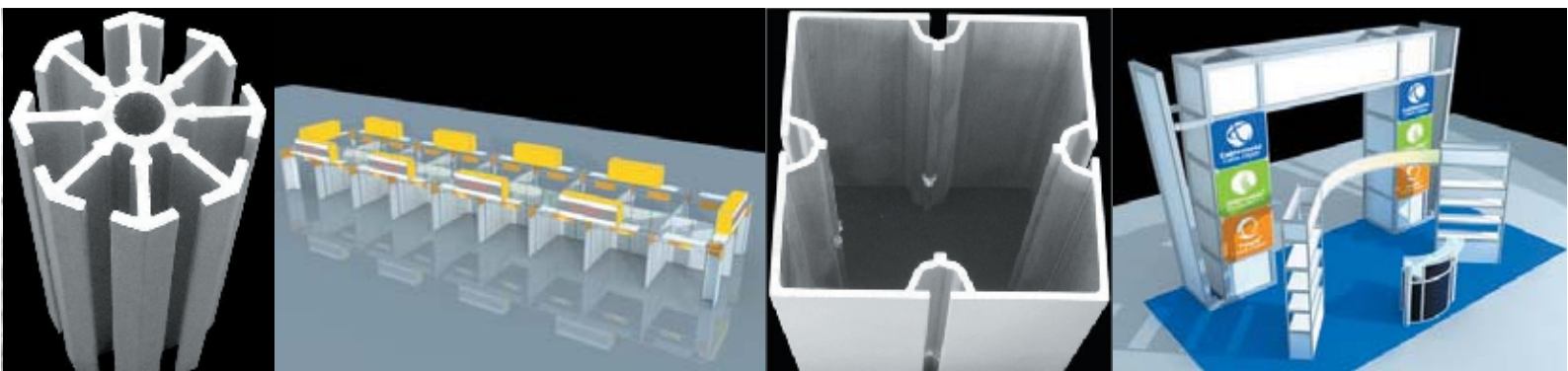

aluminium for expo solution

Alu4Expo

catalogo 2011-2012

1. Expo System	1. Profilo Ottagonale	2-4
	2. Profilo Quadrato	4-7
	3. Profilo Rotondo	8-10
	4. Profilo Ellittico	10-12
	5. Traversini	12-17
	6. Accessori di metallo	18-25
	7. Profilo di plastica	25
	8. Accessori di plastica	26-27
2. Supporti espositivi	1. Supporti per lastre e pannelli	28-30
	2. Supporti per tessuti	31-33
3. Pedane & Piedini	1. Pedane	34
	2. Piedini	35
4. Vetrine	1. Profili per vetrine	36-38
	2. Giunti per vetrine	39-42
	3. Profilo di plastica	43
	4. Accessori vari	44

Lunghezza

I profili sono disponibili in lunghezza massima di 6 metri, su richiesta specifica del cliente possono essere forniti con taglio su misura.

Colore

I profili hanno come colore standard l'alluminio anodizzato.

Note

Per disegni dettagliati www.alu4expo.com

Codice
S011

Nome
Profilo 8 vie Ø 40 mm

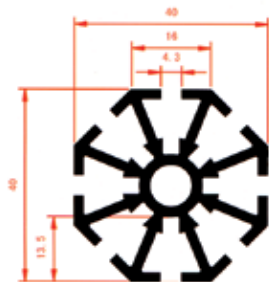

Codice
S012

Nome
Profilo 8 vie Ø 40 mm

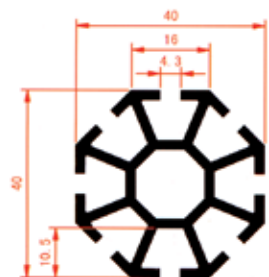

Codice
S013

Nome
Profilo 8 vie Ø 40 mm

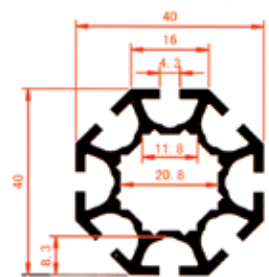

Codice
S021

Nome
Profilo ½ ottagono Ø 40 mm

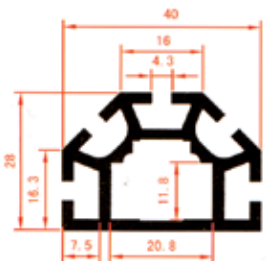

Codice
S022

Nome
Profilo ½ ottagono Ø 40 mm

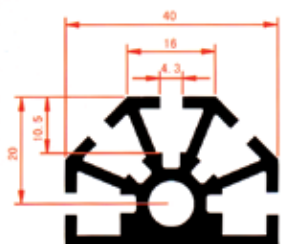

Codice
S023

Nome
Profilo ¼ ottagono Ø 40 mm

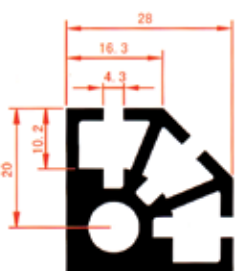

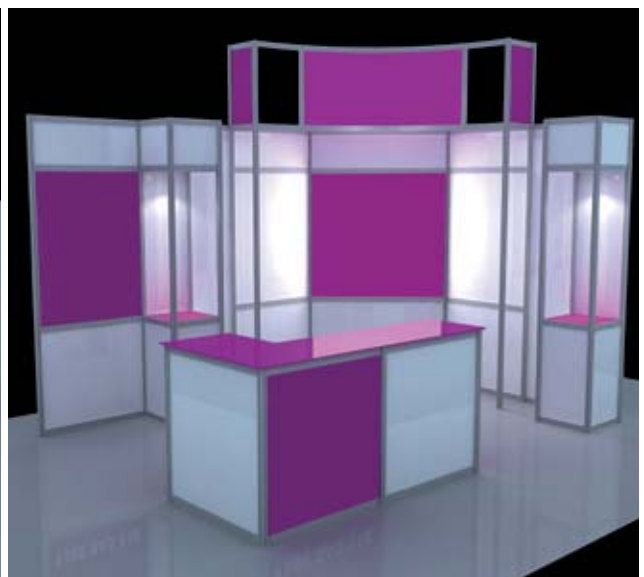
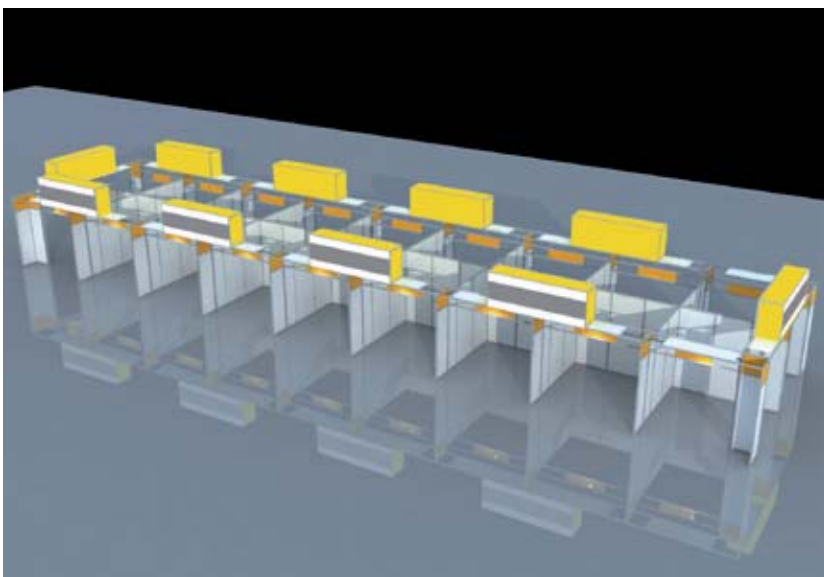
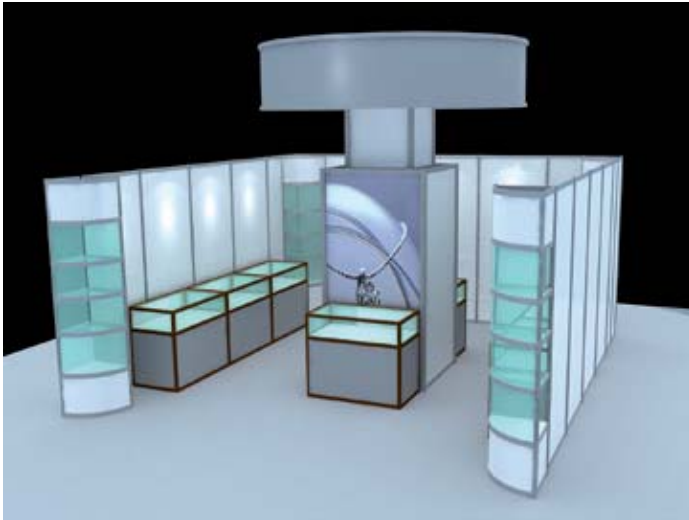
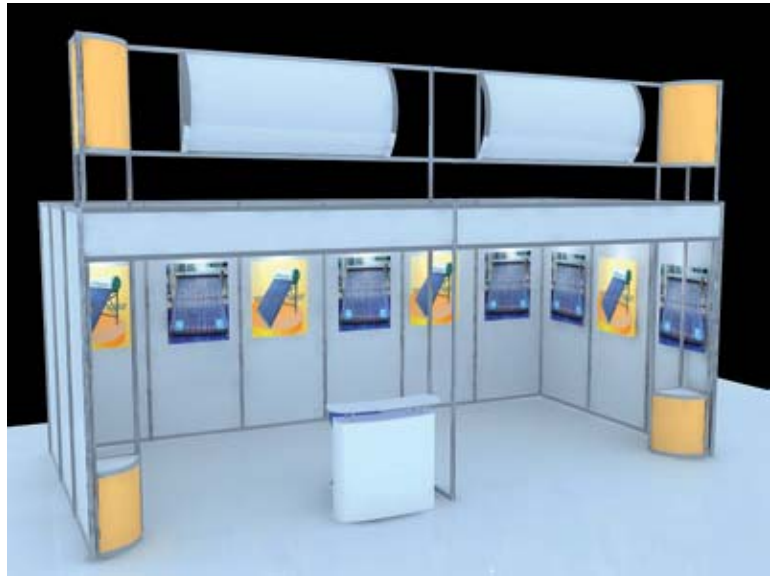

Codice
S024

Nome
Profilo 40x40 mm 8 vie

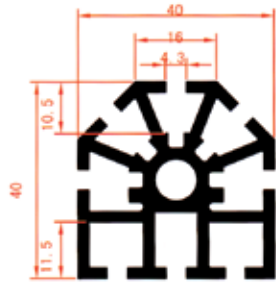

Codice
S025

Nome
Profilo 135° 4 vie

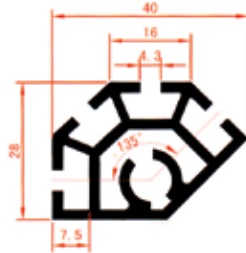

Codice
S051

Nome
Profilo 6 vie Ø 40 mm

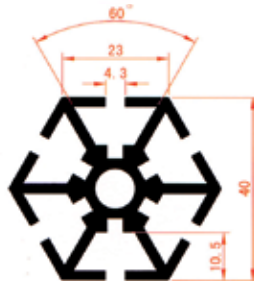

Profilo Quadrato

Codice
M041

Nome
Profilo quadrato 4 vie 40 mm

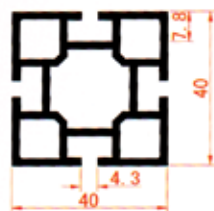

Codice
M042

Nome
Profilo quadrato 8 vie 40 mm

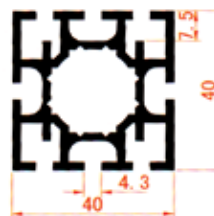

Codice
M480

Nome
Profilo rettangolare 4 vie 40/80mm

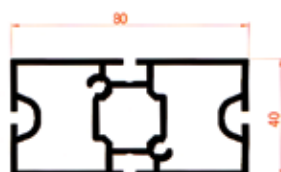

Codice
M081

Nome
Profilo quadrato 4 vie 80 mm

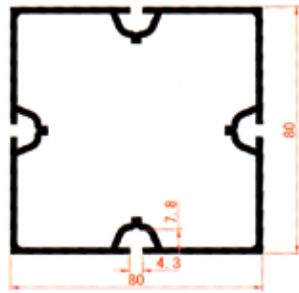

Codice
M08-A

Nome
Connettore per profilo M081



Codice
M08-B

Nome
Connettore per profilo M081



Codice
M100

Nome
Profilo quadrato 4 vie 100 mm

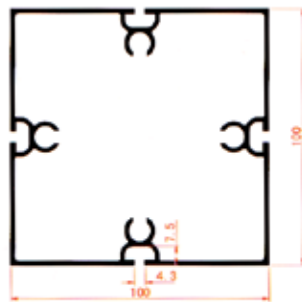

Codice
M100-A

Nome
Connettore per profilo M100



Codice
M120

Nome
Profilo quadrato 4 vie 120 mm

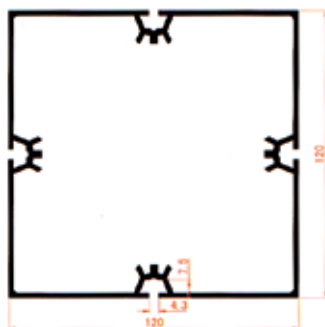

Codice
M120-A

Nome
Connettore per profilo M120



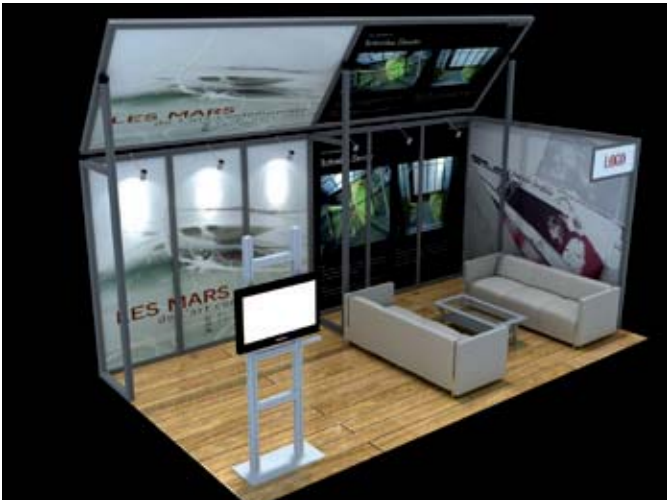
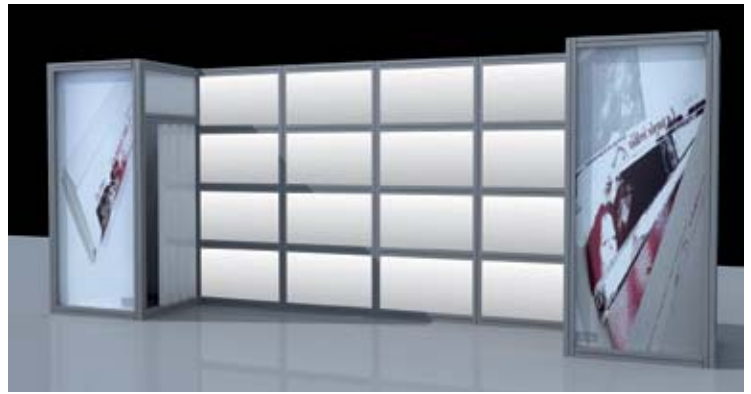
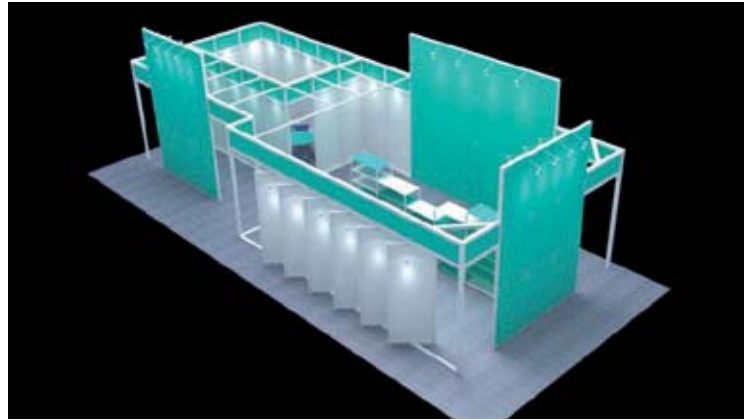
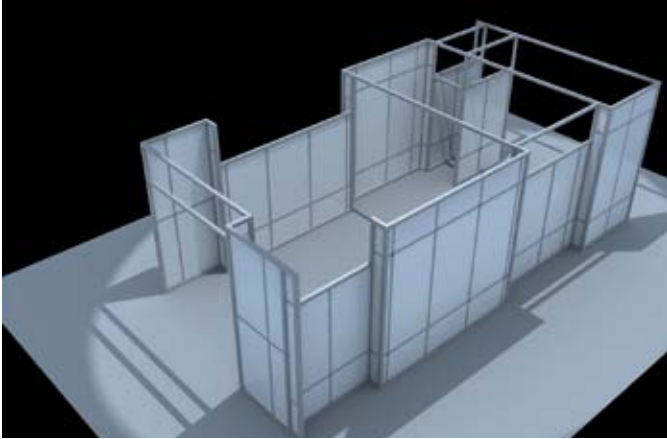

Codice
M083

Nome
Profilo triangolare 45° per M081

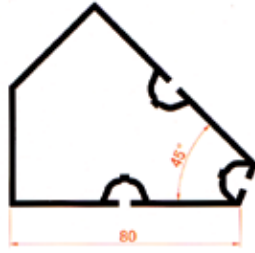

Codice
M102

Nome
Profilo triangolare 45° per M100

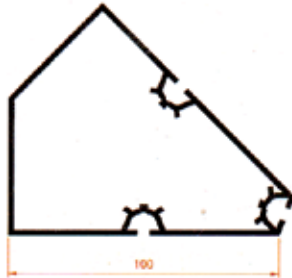

Codice
M123

Nome
Profilo triangolare 45° per M120

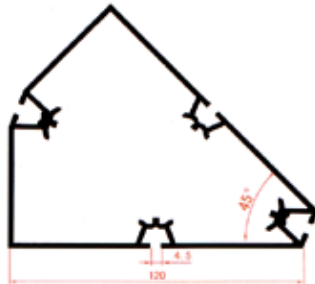

Codice
M082

Nome
Profilo quadrato smussato 4 vie 80 mm

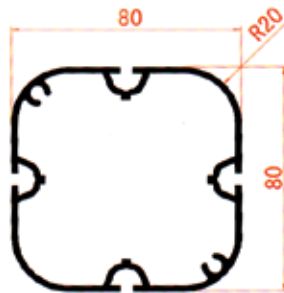

Codice
S801

Nome
Profilo rotondo 2 vie 40 mm



Codice
S802

Nome
Profilo rotondo 2 vie 40 mm

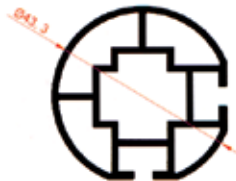

Codice
S803

Nome
Profilo rotondo 3 vie 40 mm



Codice
S804

Nome
Profilo rotondo 4 vie 40 mm

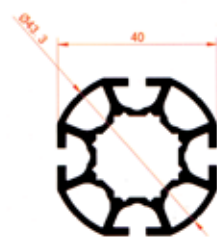

Codice
S805

Nome
Profilo rotondo 2 vie snodabile



Codice
M561

Nome
Profilo rotondo 4 vie 60 mm



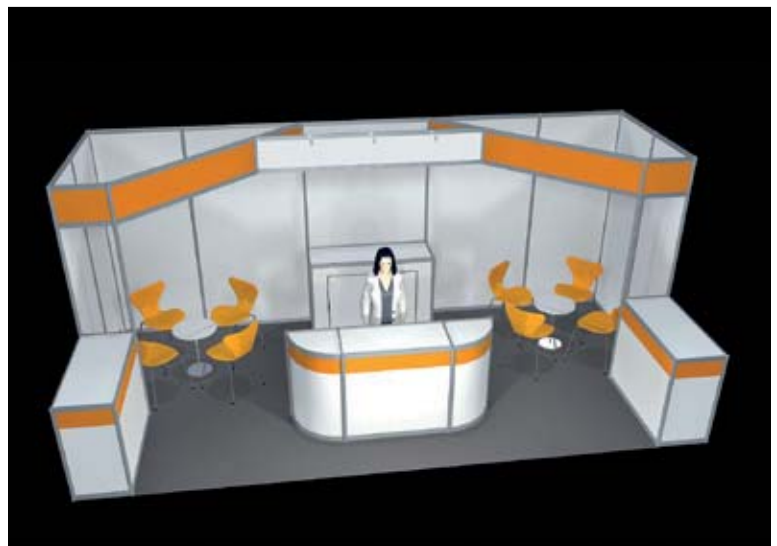
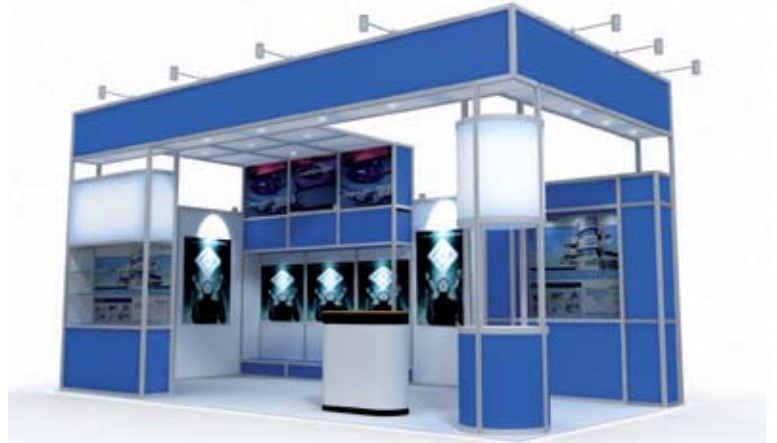
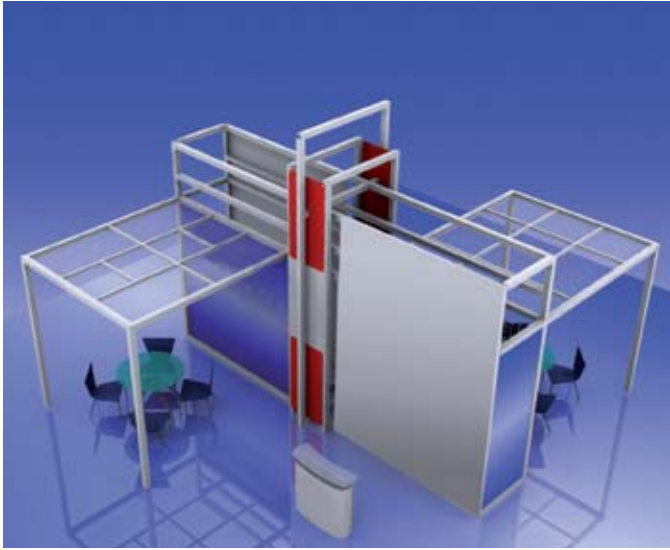

Codice
M580

Nome
Profilo rotondo 4 vie 80 mm

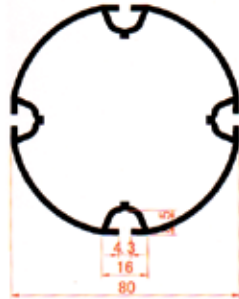

Codice
M5101

Nome
Profilo rotondo 8 vie 100 mm

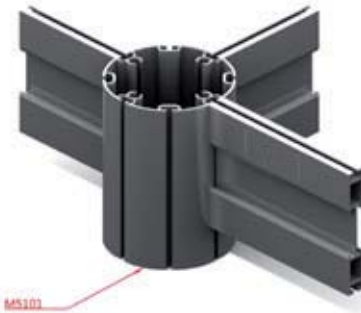
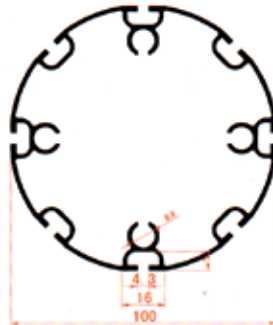

Codice
M5120

Nome
Profilo rotondo 4 vie 120 mm

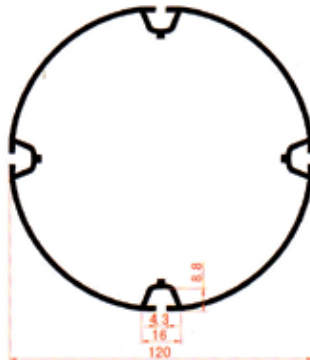

Profilo Ellittico

Codice
S230A

Nome
Profilo ovale cave esterne 230 mm



Codice
S230B

Nome
Profilo ovale cave interne 230 mm



S230B

Codice
M122

Nome
Profilo ellittico 120 mm

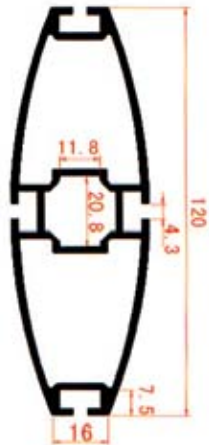

M122

Codice
M684

Nome
Profilo ellittico 40/80 mm

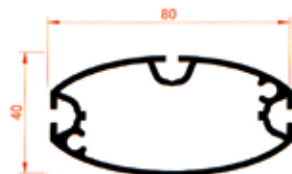

M684

Codice
M091

Nome
Profilo ogivale 45/90 mm

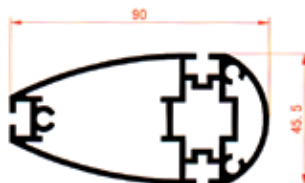

M091

Codice
 M198

Nome
 Profilo ½ ogivale 198 mm

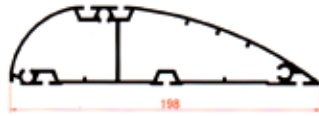

Codice
 M481

Nome
 Profilo triangolare 4 vie 50 mm

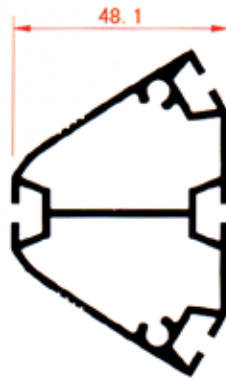

Traversino

Codice
 Z025

Nome
 Profilo una cava/25 mm

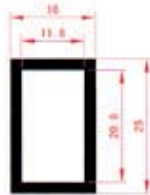

Codice
 Z031

Nome
 Profilo una cava/37 mm

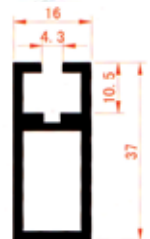

Codice:
 Z041

Nome
 Profilo due cave/40 mm



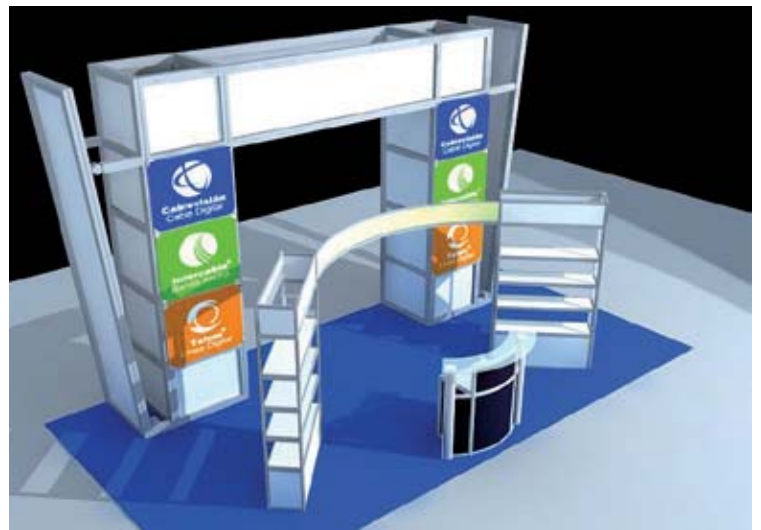
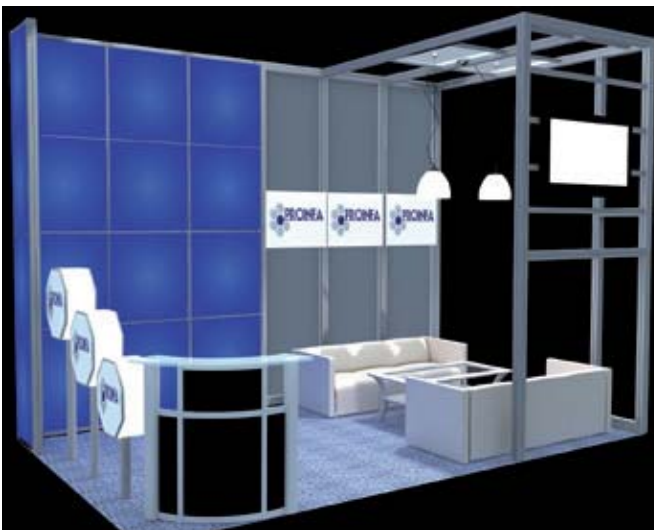
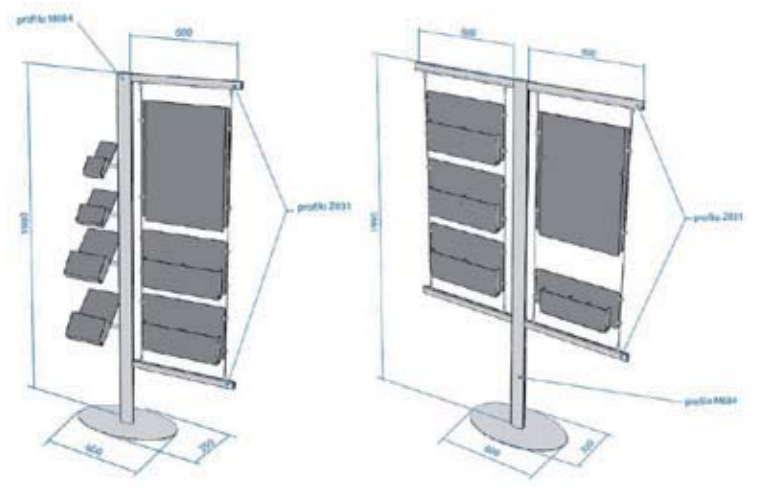

Codice
Z042

Nome
Profilo due cave/40 mm



Codice
Z043

Nome
Profilo due cave/40 mm

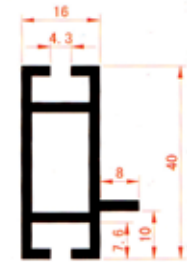

Codice
Z044

Nome
Profilo due cave/40 mm

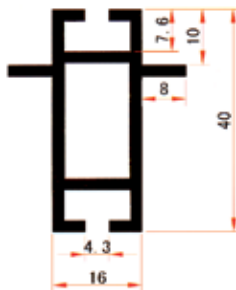

Codice
Z045

Nome
Profilo smussato 40 mm

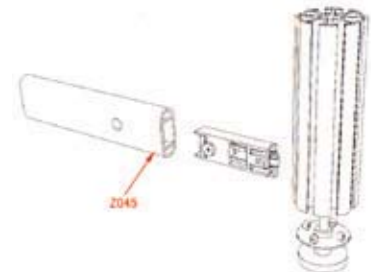
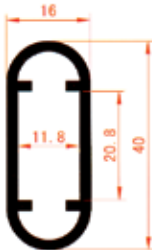

Codice
Z046

Nome
Profilo 1 cava/40 mm

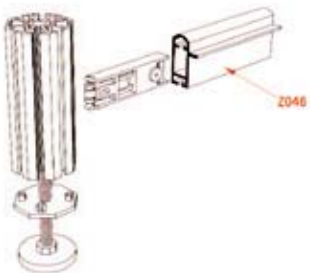
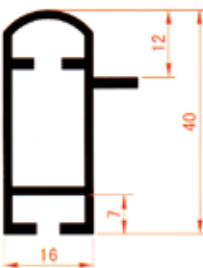

Codice
Z047

Nome
Profilo 1 cava/40 mm

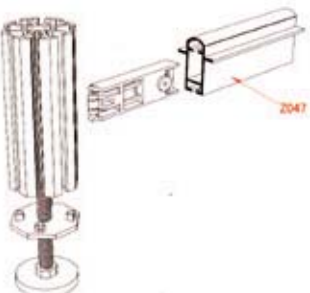
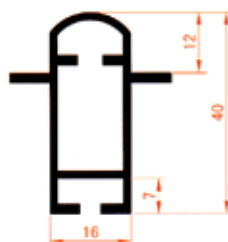

Codice
Z051
Nome
Profilo due cave/50 mm

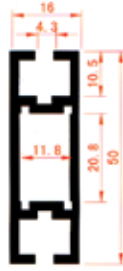

Codice
Z052
Nome
Profilo due cave laterali/50 mm



Codice
Z053
Nome
Profilo due cave/50 mm

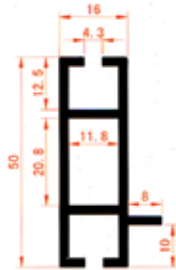

Codice
Z054
Nome
Profilo 3 cave/50 mm



Codice
Z055
Nome
Profilo una cava/50 mm

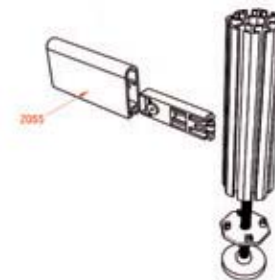
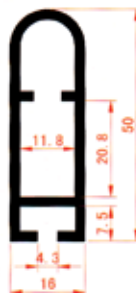

Codice
Z061
Nome
Profilo due cave/60 mm



Codice
Z071

Nome
Profilo due cave/70 mm



Codice
Z072

Nome
Profilo due cave/70 mm

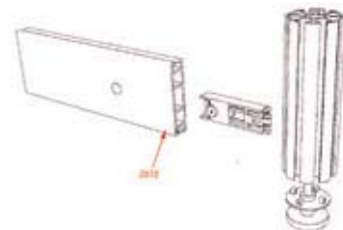

Codice
Z073

Nome
Profilo 4 cave/70 mm



Codice
Z074

Nome
Profilo 6 cave/70 mm



Codice
Z075

Nome
Profilo 2 cave/70 mm

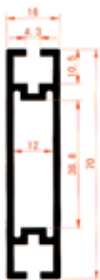

Codice
Z104

Nome
Profilo doppia trave 140 mm

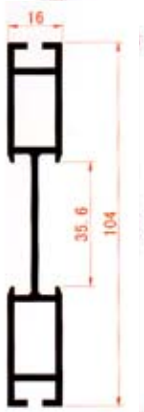

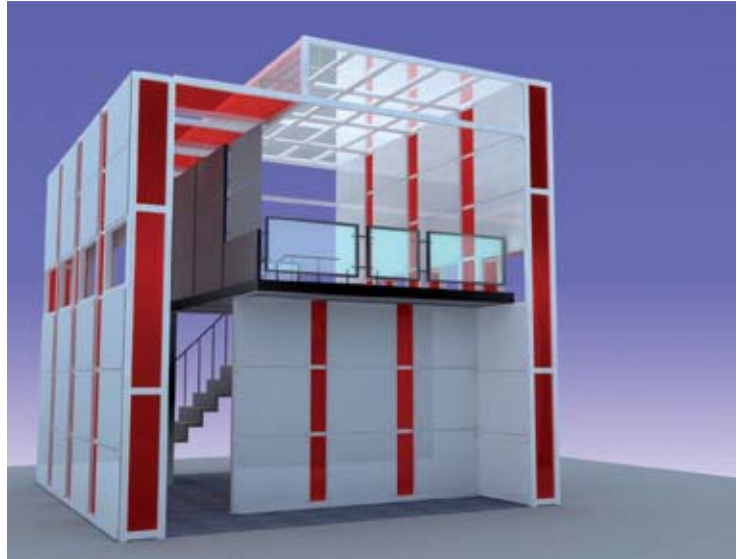
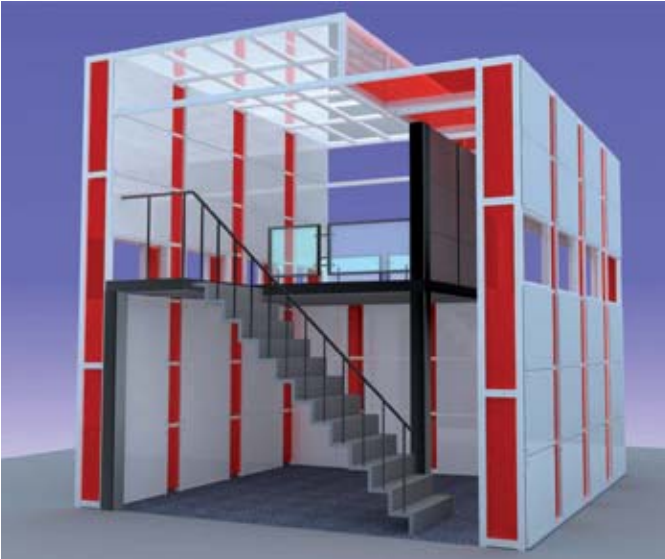
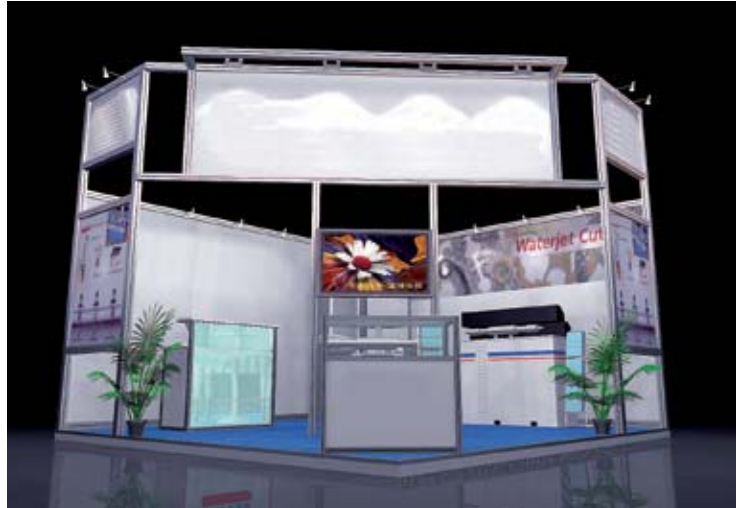
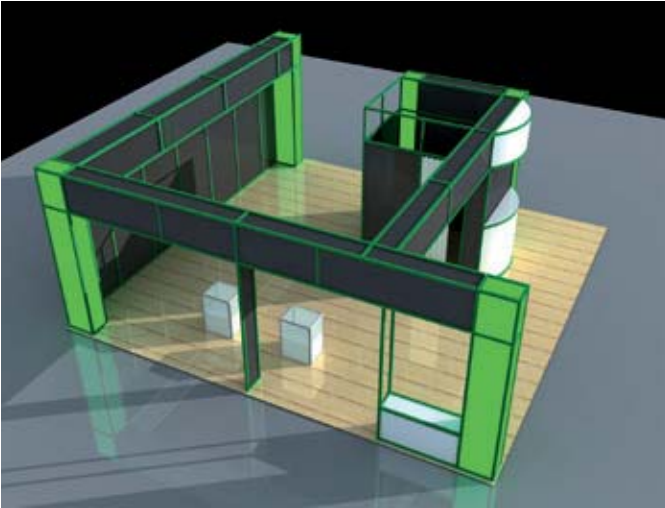

Codice
W002

Nome
Morsetto



Codice
W003

Nome
Morsetto per M041



Codice
W004

Nome
Morsetto per traversini calandrati

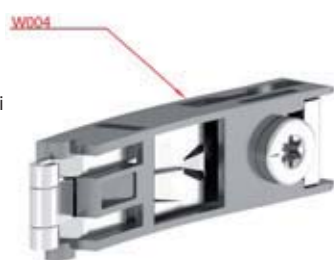

Codice
W057

Nome
Giunto snodabile per M081



Codice
W059

Nome
Giunto snodabile per M100



Codice
W061

Nome
Giunto snodabile per M120



Codice
W058

Nome
Giunto snodabile per M081



Codice
W060

Nome
Giunto snodabile per M100



Codice
W062

Nome
Giunto snodabile per M120



Codice
Q015

Nome
Inserto alluminio connettore

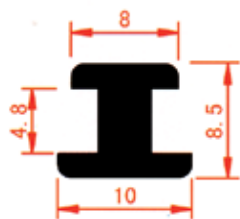

Codice
W006B

Nome
Connettore



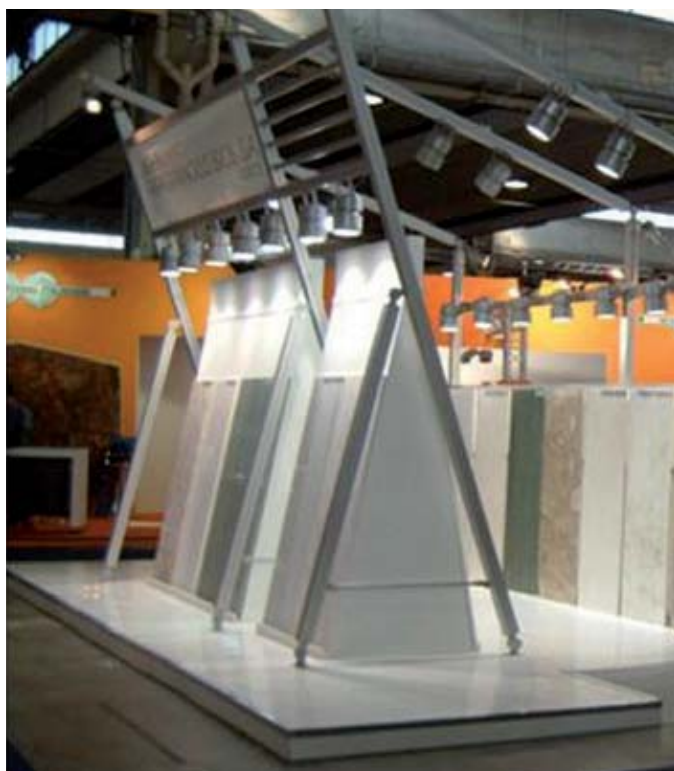
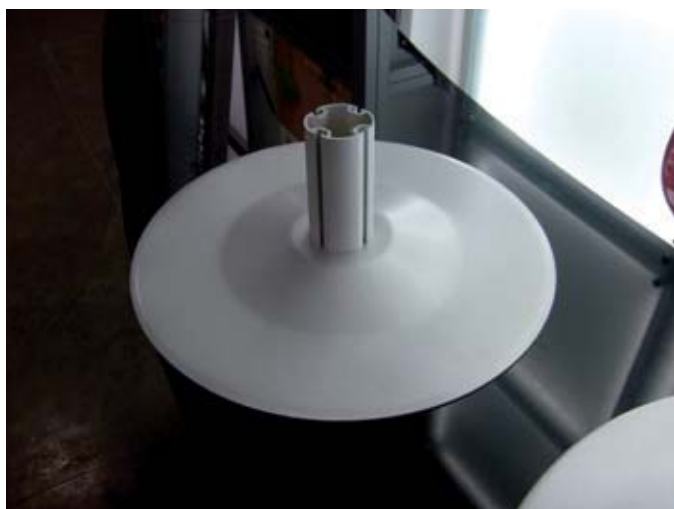

Codice
W007
Nome
Connettore per S011

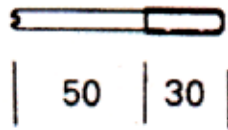

Codice
W008
Nome
Connettore per S013



Codice
W008a
Nome
Connettore per S011



Codice
W009
Nome
Giunto trasversino



Codice
W012
Nome
Rondella



Codice
W027
Nome
Vite M6 3*13 mm



Codice
W028
Nome
Vite M6 3*20 mm



Codice
W010
Nome
Connettore 55 mm

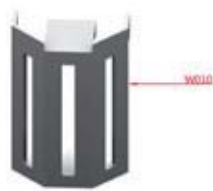

Codice
W011
Nome
Connettore 75 mm



Codice
W026
Nome
Connettore fissaggio parete



Codice
W052
Nome
Rinforzo reggi angolo



Codice
W021
Nome
Gancio fissaggio pareti



Codice
W023A
Nome
Vite per supporto

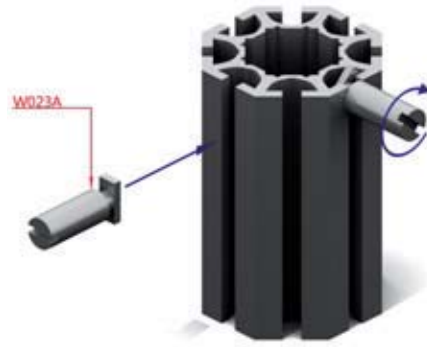
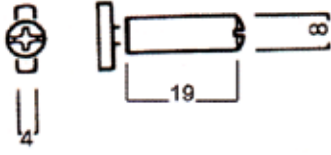

Codice
W023B
Nome
Vite per supporto



Codice
W023D
Nome
Vite nottolone reggi-
piano



Codice
W022
Nome
Gancio di fissaggio



Codice
W024
Nome
Gancio sostegno

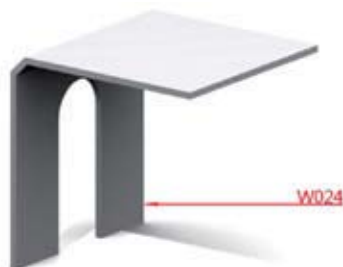

Codice
W031

Nome
Gancio ad anello



Codice
ED004

Nome
Gancio reggiborsa

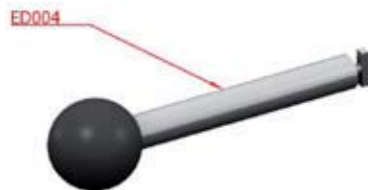

Codice
ED010

Nome
Staffa reggi mensola

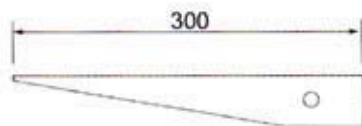

Codice
ED013

Nome
Mensola 990 x 300 mm

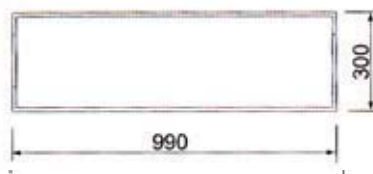

Codice
ED012

Nome
Staffa reggi mensola inclinabile

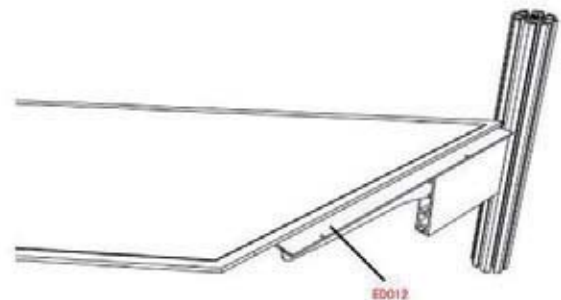
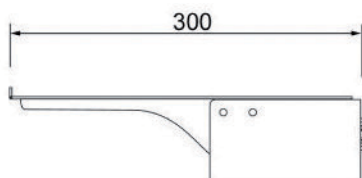

Codice
W023C

Nome
Dadi con innesto in cava

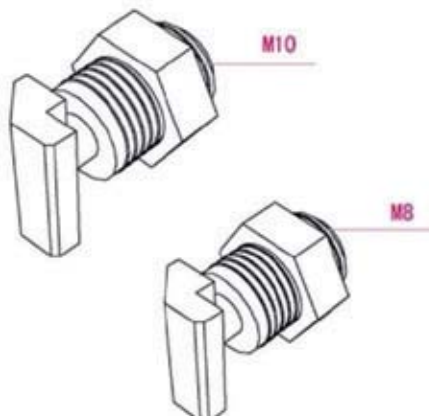

Codice
ED007

Nome
Base diametro 34 cm



Profilo in plastica

Codice
E011

Nome
Profilo blocca porta

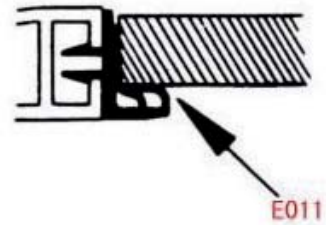
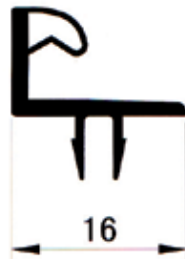

Codice
E012

Nome
Profilo blocca vetro

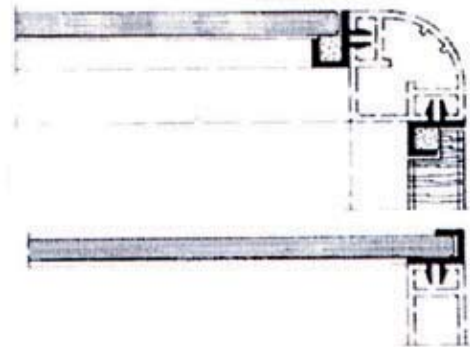
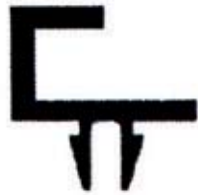

Codice
E013

Nome
Profilo supporto vetro



Codice
E014

Nome
Profilo blocca telo

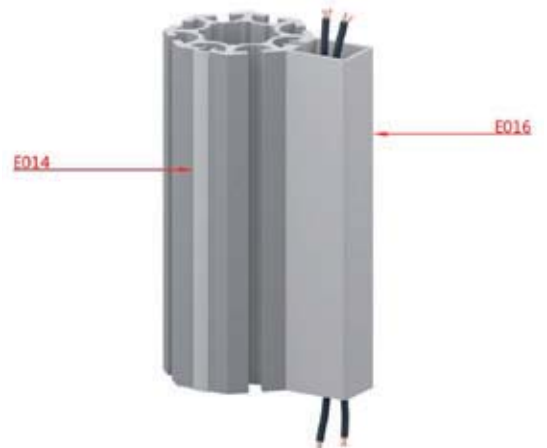

Codice
E016

Nome
Profilo nascondi cavi

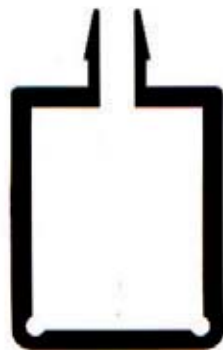

Codice
SP001

Nome
Tappo plastica per S011
S012 S013



Codice
SP002

Nome
Tappo plastica per S021
S022

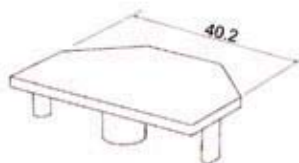

Codice
SP006

Nome
Tappo plastica per S061B

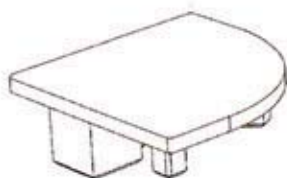

Codice
SP007

Nome
Tappo plastica per Z031



Codice
SP008

Nome
Tappo plastica per Z041

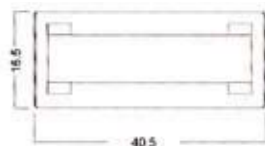

Codice
SP009

Nome
Tappo plastica per Z051



Codice
SP012
Nome
Tappo plastica per S072

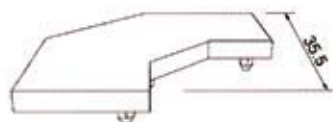

Codice
SP014
Nome
Tappo plastica per M041



Codice
SP015
Nome
Tappo plastica per M081

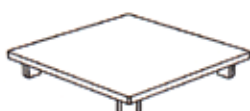

Codice
SP016
Nome
Tappo plastica per M120

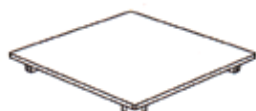

Codice
SP017
Nome
Tappo plastica per M561

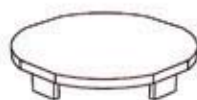

Codice
SP018
Nome
Tappo plastica per M583



Codice
SP019
Nome
Tappo plastica per M5120



Codice
SP020
Nome
Tappo plastica per M122



Codice
SP021
Nome
Tappo plastica per M684



Codice
SP022
Nome
Tappo plastica per M082



Codice
 W034
 Nome
 Reggivetto 1 lato

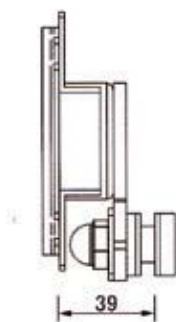
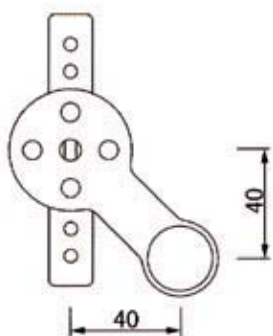

Codice
 W035
 Nome
 Reggivetto 2 lati

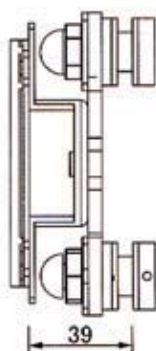
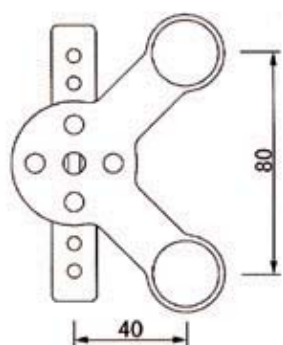

Codice
 W036
 Nome
 Reggivetto 3 lati

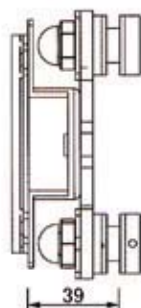
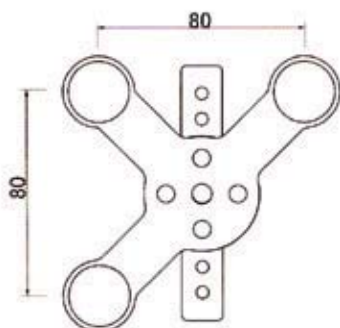

Codice
 W037
 Nome
 Reggivetto 4 lati

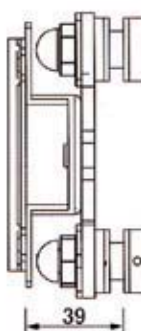
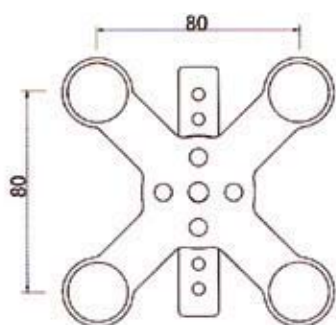



Codice
W03A
Nome
Gancio tessivetro (senza foratura lastra)



Codice
W038
Nome
Gancio reggi vetro

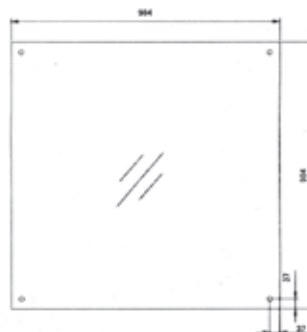

Codice
E008
Nome
Profilo in plastica serra vetro



Codice
E009
Nome
Profilo in plastica per fissaggio

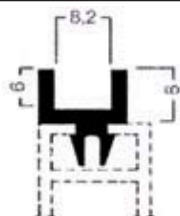

Codice
E010
Nome
Profilo in plastica per fissaggio

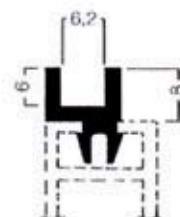

Codice
Q017
Nome
Profilo in alluminio per fissaggio

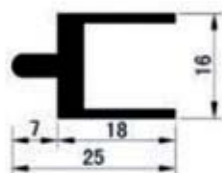

Codice
W054
Nome
Gancio reggilastra/vetro



Codice
FS01

Nome
Gancio reggitelo



Codice
FS02

Nome
Gancio reggitelo

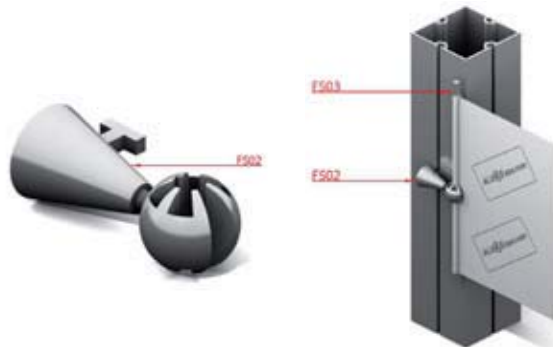

Codice
FS03

Nome
Tubo reggigrafica



Codice
F006

Nome
Profilo quadrato per fissaggio textile



Codice
F007

Nome
Profilo quadrato per fissaggio textile angolare



Codice
FG008

Nome
Tappo in plastica per F007



Codice
F002
Nome
Profilo in alluminio per fissaggio

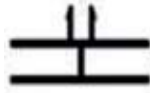

Codice
F003
Nome
Profilo in alluminio per fissaggio

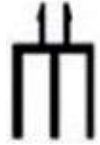

Codice
F004
Nome
Profilo in alluminio per fissaggio



Codice
F005
Nome
Profilo in alluminio per fissaggio

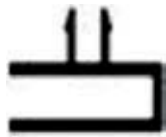

Codice
E030
Nome
Profilo flessibile silicone per cucitura tessuto



Codice
M043
Nome
Profilo in alluminio per fissaggio tela a M041

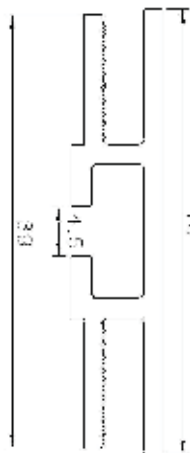

Codice
M0811
Nome
Profilo in alluminio per fissaggio tela a M081



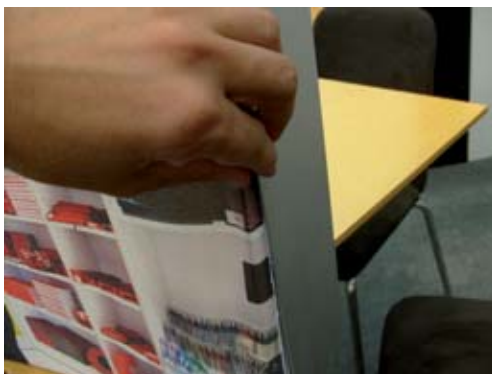

Codice
FW001

Nome
Profilo bordo pedana

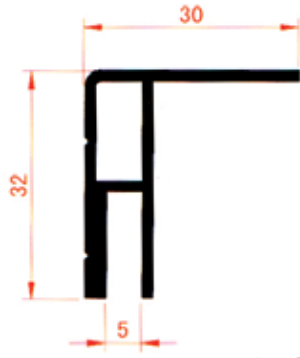

Codice
FW002

Nome
Pannello pedana

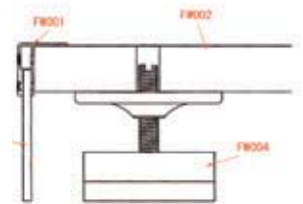

Codice
FW003

Nome
Perno di serraggio

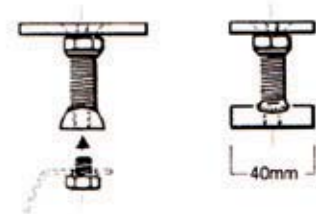
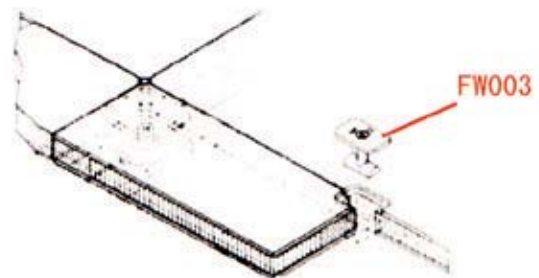
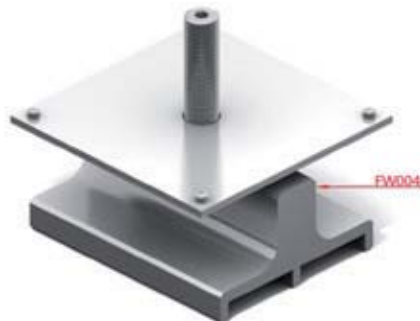

Codice
FW004

Nome
Piedino regolabile

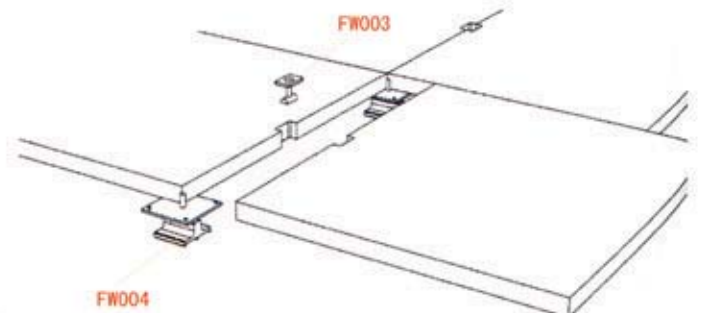

Codice
W013

Nome
Piedino regolabile per S011 S012 S013



Codice
W014

Nome
Piedino regolabile per S011 S012 S013



Codice
W015

Nome
Piedino regolabile per M041



Codice
W016

Nome
Piedino regolabile per M081



Codice
W017

Nome
Piedino regolabile per M120

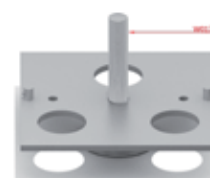

Codice
W018

Nome
Piedino regolabile per M561

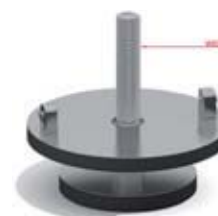

Codice
W019

Nome
Piedino regolabile per M583



Codice
S066

Nome
Profilo Angolare 135° 4 vie

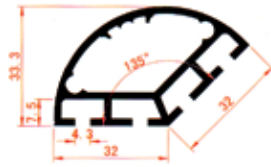

Codice
S067

Nome
Profilo Angolare 120° 4 vie

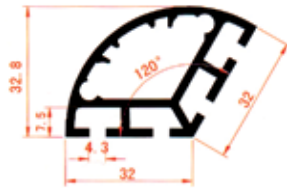

Codice
S063

Nome
Profilo triangolare 135°

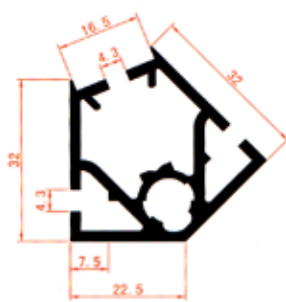

Codice
S064

Nome
Profilo triangolare 3 vie

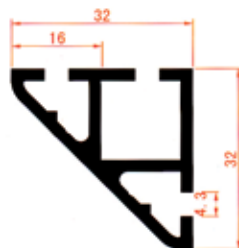

Codice
S072

Nome
Profilo triangolare 2 vie

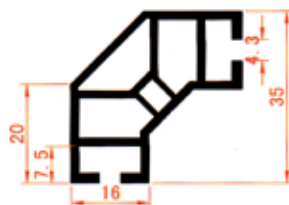

Codice
S073

Nome
Profilo triangolare 2 vie

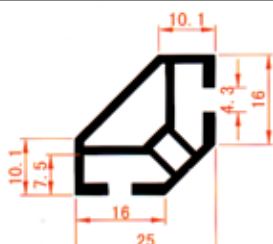



Codice
S074

Nome
Profilo triangolare 3 vie

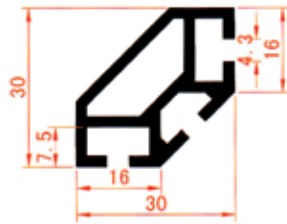

Codice:
S062

Nome:
Profilo quadrato 2 vie 32 mm

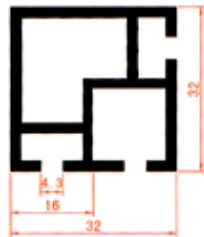

Codice
S061A

Nome
Profilo 32x32 mm ¼ cerchio

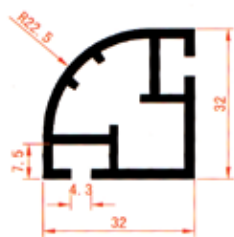

Codice
S061B

Nome
Profilo 32x32 mm ¼ cerchio

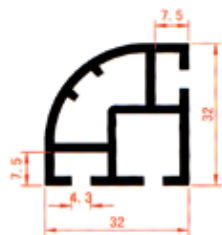

Codice
S065

Nome
Profilo 24x16 mm ¼ cerchio



Codice:
S070

Nome
Profilo 20x20 mm ¼ cerchio



Codice
Q016

Nome
Profilo in alluminio per ante scorrevoli



Codice
W039
Nome
Giunto angolare 90° 2 vie per S065

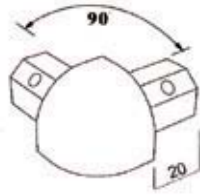

Codice
W040
Nome
Giunto angolare 90° 3 vie per S065

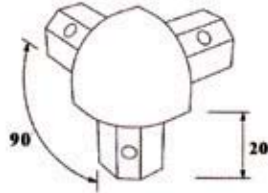

Codice
W041
Nome
Giunto angolare 90° 2 vie per S061A

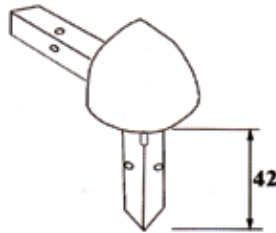

Codice
W042
Nome
Giunto angolare 90° 3 vie per S061B



Codice
W047
Nome
Giunto angolare 90° 3 vie per S061A



Codice
W051
Nome
Giunto angolare 135° 2 vie per S061B

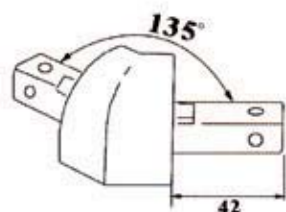

Codice:
W053

Nome:
Giunto angolare 135° 2 vie per S061B



Codice:
W057

Nome:
Giunto angolare 90° 3 vie per S062



Codice:
W058

Nome:
Giunto angolare 135° 2 vie per S064



Codice:
W059

Nome:
Giunto angolare 135° 3 vie per S063 e S064



Codice:
W061

Nome:
Giunto angolare 90° 3 vie per S062 e S064





Codice:
W062

Nome:
Giunto angolare 90° 3 vie per S062 e S064



Codice:
W063

Nome:
Giunto angolare 90° 3 vie per S073



Codice:
W064

Nome:
Giunto angolare 90° 3 vie per S070



Codice:
W065

Nome:
Giunto angolare 90° 3 vie per S074



Codice:
W066

Nome:
Giunto angolare 90° 3 vie per S061A e Z054



Codice:
W067

Nome:
Giunto angolare 90° 4 vie per S061A e Z054



Codice:
E001
 Nome:
Profilo superiore antescorrevoli



Codice:
E002
 Nome:
Profilo inferiore antescorrevoli

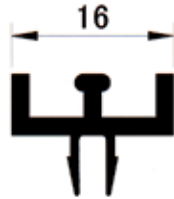

Codice:
E003
 Nome:
Profilo contenitivo

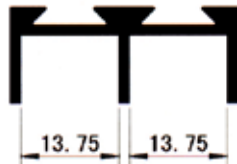

Codice:
E004
 Nome:
Profilo scorrevole

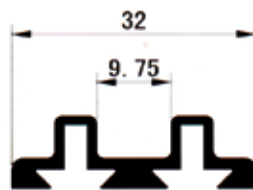

Codice:
E005
 Nome:
Profilo



Codice:
E006
 Nome:
Profilo per fissaggio



Codice:
E007
 Nome:
Profilo per fissaggio



Codice:
E017
 Nome:
Profilo per fissaggio

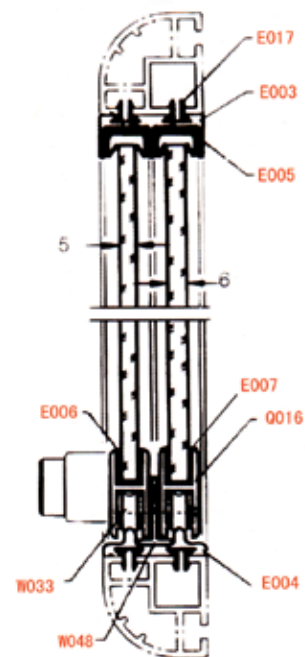

Codice:
E019

Nome:
Profilo superiore antescorrevoli

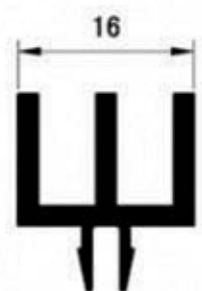

Codice:
E020

Nome:
Profilo inferiore antescorrevoli

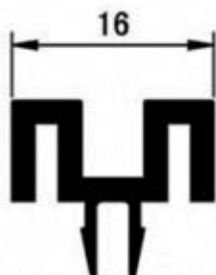

Codice:
W033

Nome:
Slitta con rotella per ante scorrevoli

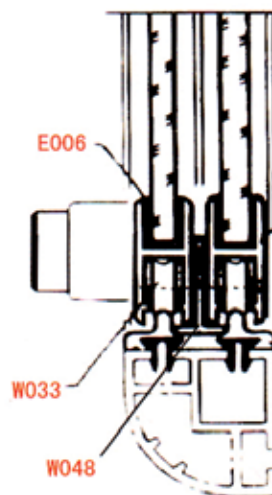

Codice:
W029A

Nome:
Rotella girevole



Codice:
W029B

Nome:
Rotella girevole con freno



AGENTE O DISTRIBUTORE DI ZONA

Alu4Expo

Alu4Expo srl

Via Brescia 41 • 25014 Castenedolo (Brescia)
Tel. +39 030 2130290 • Fax +39 030 2136217
info@alu4expo.com • www.alu4expo.com

GRUPPO SIR
www.sirspa.it

